

## Ordering Information:

A2541HWV-XP -  $\frac{****}{1}$  -  $\frac{***}{2}$  -  $\frac{*}{3}$  -  $\frac{***}{4}$  -  $\frac{***}{5}$

- Part No.
- Size(H):  
 (blank): 8.50mm  
 H71: 7.10mm  
 H57: 5.70mm  
 H50: 5.00mm  
 H35: 3.50mm(B:B-0.50mm)  
 H110: 11.00mm
- Size(D):  
 (blank): 3.20mm(H85,H71,H57,H50,H110)  
 D26: 2.60mm(H35)  
 D21: 2.10mm(H50)
- Finish:  
 (blank): Gold over Nickel  
 T: Tin over Nickel
- Material:  
 (blank): PBT,UL94V-0  
 6T: Nylon 6T,UL94V-0  
 GWT: Nylon 6T,UL94V-0,GWT 750°C

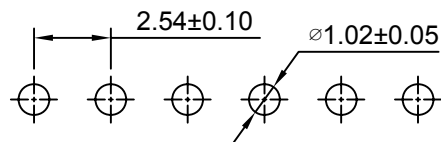
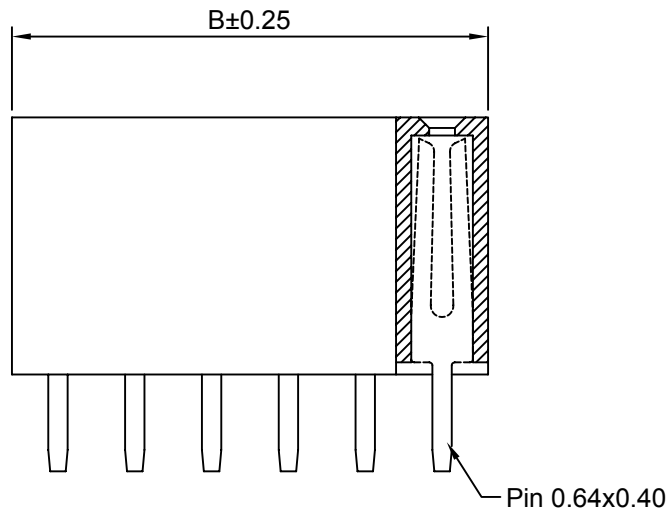
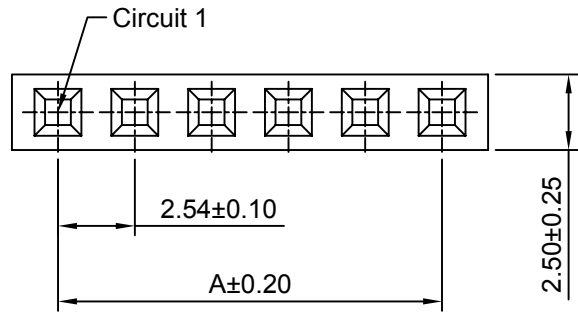

P.C.B LAYOUT

## SPECIFICATIONS:

Current Rating: 3A AC,DC  
 Voltage Rating: 250V AC,DC  
 Temperature Range: -40°C ~ +105°C  
 Contact Resistance: 20mΩ Max  
 Insulation Resistance: 1000MΩ Min  
 Withstanding Voltage: 1500V AC/minute  
 Pin Material: Brass/Gold over Nickel  
 Material: PBT,UL94V-0(Black)

## Ordering Information & Dimensions

Circuits	Dim(mm)		Circuits	Dim(mm)		Circuits	Dim(mm)	
	A	B		A	B		A	B
2P	2.54	5.58	15P	35.56	38.60	28P	68.58	71.62
3P	5.08	8.12	16P	38.10	41.14	29P	71.12	74.16
4P	7.62	10.66	17P	40.64	43.68	30P	73.66	76.70
5P	10.16	13.20	18P	43.18	46.22	31P	76.20	79.24
6P	12.70	15.74	19P	45.72	48.76	32P	78.74	81.78
7P	15.24	18.28	20P	48.26	51.30	33P	81.28	84.32
8P	17.78	20.82	21P	50.80	53.84	34P	83.82	86.86
9P	20.32	23.36	22P	53.34	56.38	35P	86.36	89.40
10P	22.86	25.90	23P	55.88	58.92	36P	88.90	91.94
11P	25.40	28.44	24P	58.42	61.46	37P	91.44	94.48
12P	27.94	30.98	25P	60.96	64.00	38P	93.98	97.02
13P	30.48	33.52	26P	63.50	66.54	39P	96.52	99.56
14P	33.02	36.06	27P	66.04	69.08	40P	99.06	102.10

SHENZHEN KINGHELM ELECTRONIC CO., LTD.			WWW.BDS666.COM		
KH-A2541HWV-4P			0755-83044319		
Unit	Scale	Sheet	Title :		
mm	4:1	1 of 1			
Draw BY:		Approved :		<b>2.54mm PITCH</b> <b>180° SINGLE ROW</b> <b>BOX HEADER</b>	
Tony Su		Jack Yin			
General Tolerance					
A1	updated version	2018.04.13	x.xx≤0.25 x.xx≤0.20 x.xxx≤0.15	ANGLE± 	DRAW NO : A2541HWV-XP
A0	NEW RELEASE	2005.07.01			
REV	DESCRIPTION	DATE			
					REV A1