

# Kinghelm®

型号: KH-I PEX-SMAKWE-RG137-Q120MM

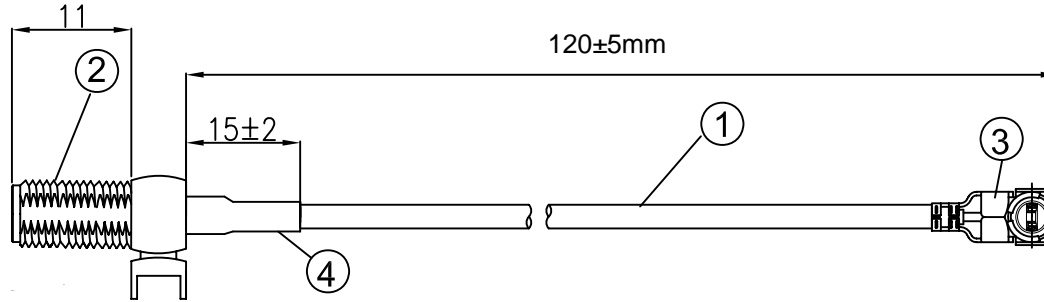

**NOTES:**

1. ELECTRICAL:
  - 1.1. VOLTAGE RATING:DCV 300V 10MS
  - 1.2. CONDUCTANCE RESISTANCE: 3.0 OHM/MAX.
  - 1.3. INSULATION RESISTANCE: 5.0M OHM/MIN.
  - 1.4. THE CABLE SHOULD BE 100% ELECTRICAL TEST
  - 1.5. IT SHOULD BE NO ANY OPEN/SHORT, MISWIRING AND INTERMITTENT FAILURES.
2. MATERIAL:
  - 2.1. SEE TABLE
3. ALL COMPONENTS ARE RoHS COMPLIANT.

ITEM NO.	PART NUMBER	DESCRIPTION	QTY.
④	套管	黑色热缩套管, OD:2.0MM	AS
③	端子	高仿I-PEX, 1.37端子, 镀金	1
②	接头	SMA母头母针, 带4个脚, 11牙, 镀金, 外螺内孔	1
①	同轴线	RF1.37黑线, OD: 1.37mm	AS

深圳市金航标电子有限公司

WWW.BDS666.COM

KH-I PEX-SMAKWE-RG137-Q120MM

0755-83044319

ALL DIMENSION ARE IN MM

DRAWN James DATE 2020-04-15

CHKD. Frank 2020-04-15

COMPUTER GENERATED IN SOLIDWORKS

APPD. Scott 2020-04-15

DO NOT SCALE THIS DRAWING

I-PEX1.37 TO SMA /F L=120mm

PROJECTION

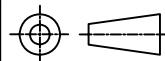

GENERAL TOLERANCE FOR ANGLES X.X X.XX X.XXX  
± 1° ± 0.3 ± 0.25 ± 0.150

SIZE Number

**B**

REV

**A**

SCALE: Free

TYPE

SHEET 1 OF 1

CUSTOMER P/N: