

REV	DESCRIPTION	DWN	DATE	APPROVEN
A	FIRST ISSUE	XIEFENG	2022/06/15	Mr.chen

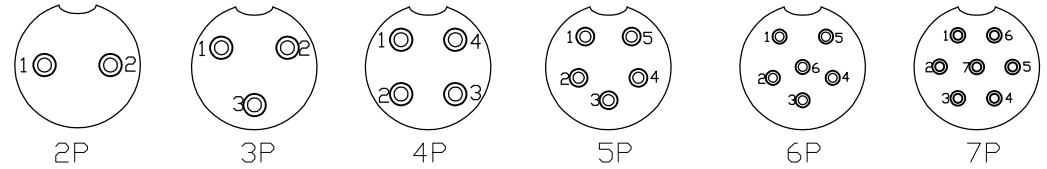
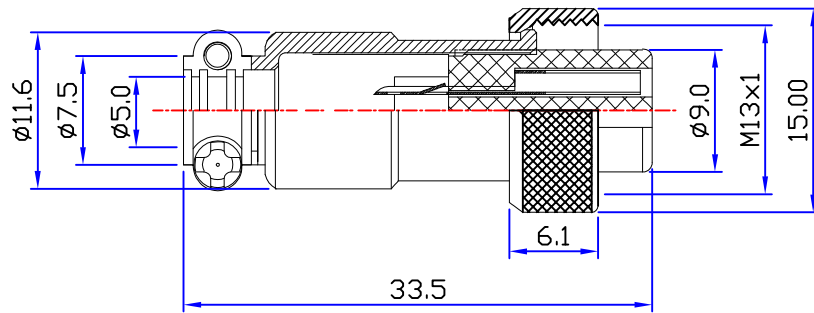

Material and specifications

- Coupling Threaded coupling
- Shell material Zinc alloy with Nickel Plate
- Insert material bakelite
- Contact material copper Silver Plate/Nickel
- Termination Solder
- Mating cycle 500
- Cable diameter -20℃ +85℃

Technology parameter						
NO.of contacts	2	3	4	5	6	7
Rated current (A)	5	5	5	5	5	5
Operation limit voltage(AC.V.rms)	200	125	125	125	125	125
Withstanding voltage(AC.V.rms) 1 minute	1500	1500	1500	1500	1500	1500
Insulation resistance(mΩ)	2000	2000	2000	2000	2000	2000
Contact resistance (mΩ)	5	5	5	5	5	5
Solder cup mouth aperture	∅0.8	∅0.8	∅0.8	∅0.8	∅0.8	∅0.8
Solder inter diameter	∅1.2	∅1.2	∅1.2	∅1.2	∅1.2	∅1.2

NOTE:		Tolerance	UNLESS OTHERWISE SPECIFIED TOLERANCES FOR INCHES ARE 0.5-8MM±0.10MM 8-30MM±0.15MM 30-120MM±0.20MM	深圳市金航标电子有限公司		www.kinghelm.com.cn	
DRAWN: XIEFENG	DATE: 22/06/15			SHENZHEN KINGHELM ELECTRON CO.,LTD.		0755-28190160	
CHECKED:		VIEW		Name: GX12 FEMALE CONNECTOR			
APPROVALS:		UNIT	MM	Product NO. KH-GX12-3P			REV A
		SCALE	1 : 1	CAD FILE H/companydrawings/BD			SHEET: 1 OF 1

REV	DESCRIPTION	DWN	DATE	APPROVEN
A	FIRST ISSUE	XIEFENG	2022/06/15	Mr.chen

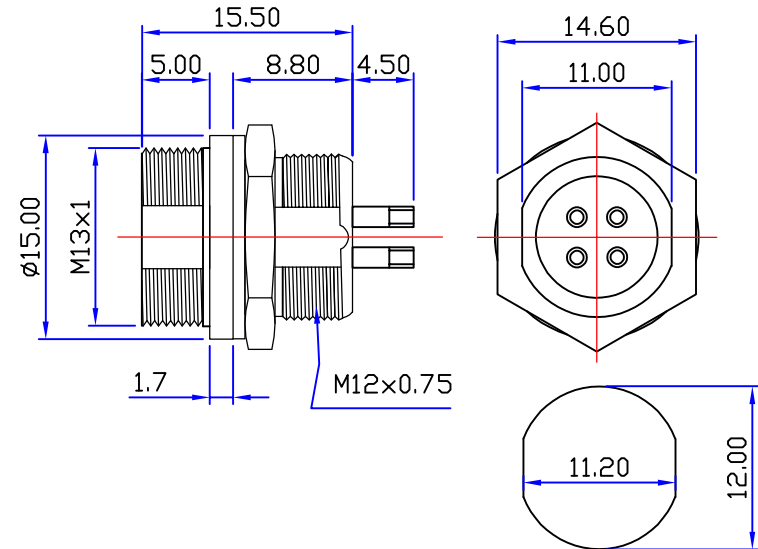
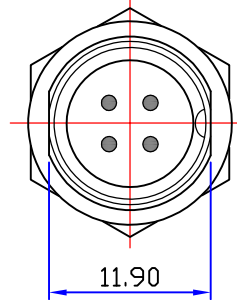
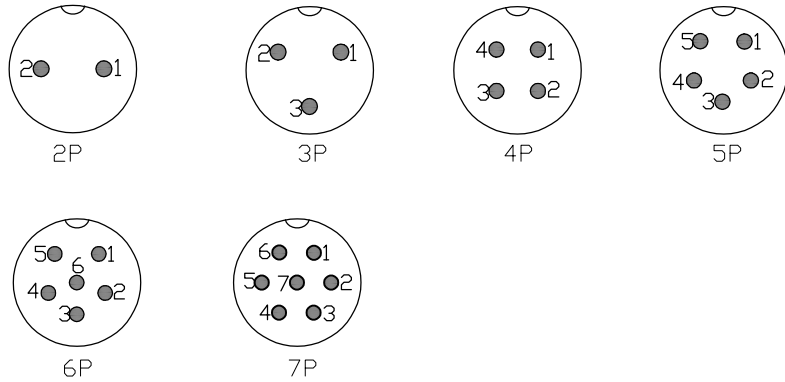

RECOMMENDED MOUNTING HOLE

Material and specifications

Coupling	Threaded coupling
Shell material	Brass with Nickel Plate
Insert material	bakelite
Contact material	copper Silver Plate/Nickel
Termination	Solder
Mating cycle	500
Cable diameter	-20℃ +85℃

Technology parameter						
NO.of contacts	2	3	4	5	6	7
Rated current (A)	5	5	5	5	5	5
Operation limit voltage(AC.V.rms)	200	125	125	125	125	125
Withstanding voltage(AC.V.rms) 1 minute	1500	1500	1500	1500	1500	1500
Insulation resistance (mΩ)	2000	2000	2000	2000	2000	2000
Contact resistance (mΩ)	5	5	5	5	5	5

NOTE:		Tolerance	UNLESS OTHERWISE SPECIFIED TOLERANCES FOR DIMENSIONS ARE 0.5-8MM±0.10MM 8-30MM±0.15MM 30-120MM±0.20MM	深圳市金航标电子有限公司		www.kinghelm.com.cn	
DRAWN: XIEFENG	DATE: 22/06/15			SHENZHEN KINGHELM ELECTRON CO.,LTD.		0755-28190160	
CHECKED:		VIEW		Name: GX12 MALE CONNECTOR			
APPROVALS:		UNIT	MM	Product NO. KH-GX12-3P			REV A
		SCALE	1 : 1	CAD FILE H/companydrawings/BD			SHEET: 1 OF 1