

REV.	ECN NO.	DESCRIPTION	DATE	DESIGN
A1.	/.	Revise Drawing	21.01.14	LiHui

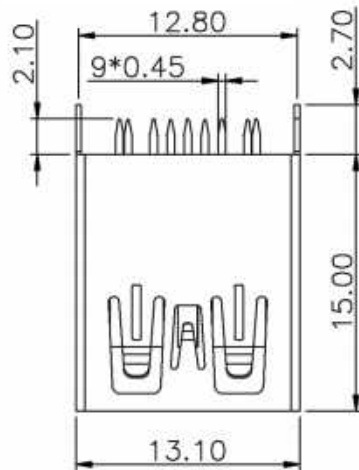

PIN NUMBER	SIGNAL NAME
PIN 1	Vbus
PIN 2	D-
PIN 3	D+
PIN 4	GND
PIN 5	StdA_SSRX-
PIN 6	StdA_SSRX+
PIN 7	GND_DRAIN
PIN 8	StdA_SSTX-
PIN 9	StdA_SSTX+
SHELL	GND

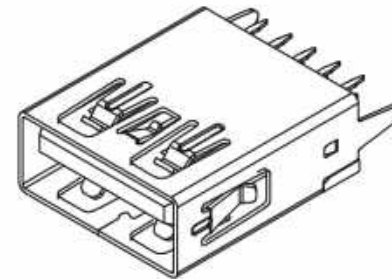

3D VIEW

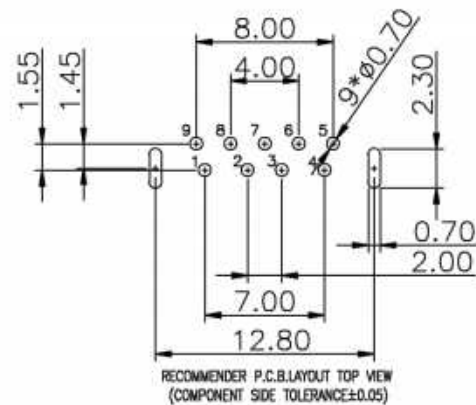
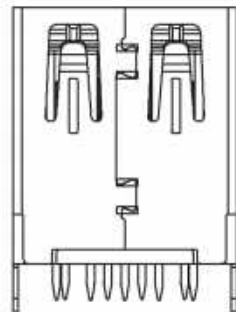
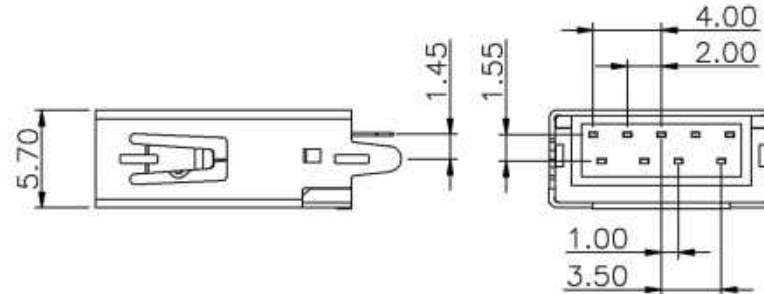
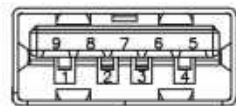

NOTES:

- MATERIAL:
 - HOUSING: LCP ,COLOR IS BLUE;
 - CONTACT: BRASS(H65 T=0.20&0.25mm);
 - SHELL: COLD ROLLED IRON(SGCC T=0.30mm);
- ELECTRICAL:
 - VOLTAGE RATING: 30V DC ;
 - CURRENT RATING: 1.5A ;
 - CONTACT RESISTANCE: 30MILLIOHMS MAX.;
 - WITHSTAND VOLTAGE: 100V AC RMS 50(60)Hz,1MIN.;
 - INSULATION RESISTANCE: 100MEG OHMS MIN @500V DC;
- MECHANICAL:
 - MATING FORCE: 35N MAX.;
 - UNMATING FORCE: 5~35N ;
 - OPERATING LIFE: 1500 CYCLES MIN.;
- PLATING:
 - TERMINAL:
 - NI PLATING OVER ALL,
 - Tin PLATING ON SOLDER AREA,
 - Au G/Fu" ON CONTACT AREA;
 - SHELL: NI PLATING OVER ALL;
- ENVIRONMENTAL:
 - STORAGE TEMPERATURE RANGE: -40°C~+85°C;
 - OPERATION TEMPERATURE RANGE: -25°C~+70°C;

Shenzhen Kinghelm Electronics Co., Ltd.

KH-3.0AF180ZJ-15

www.kinghelm.net

UNLESS OTHERWISE
GENERAL TOLERANCE:
L_{xxx} ±0.10
L_{xx} ±0.20
L_x ±0.30

USB 3.0 Type-A Female, 180°,
L=15.0mm, Flat Mouth, Straight DIP

P/N: 09.03.02.027
DWG NO:

THIRD ANGLE PROJECTION

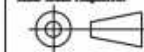

UNIT:	SCALE:	SIZE:	SHEET:	REV.
MM	1:1	A4	1/1	A1

ANGULAR:
L_{xx'} ±1°
L_{x'} ±3°
L' ±5°

DRAWN:

CHECKED:

APPROVED: